

## C RANGE

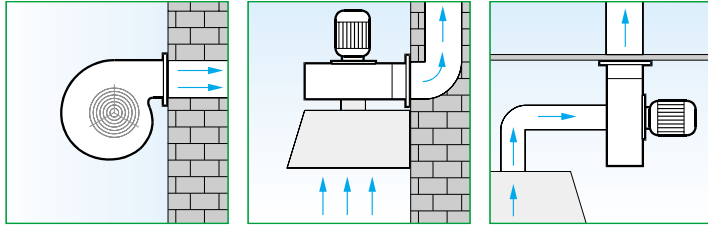

- Suitable for mounting on flat roofs of commercial, industrial buildings and blocks of flats.
  - Asynchronous, self-ventilating, ball-bearing-mounted induction motor with IP54 protection.
  - Galvanized steel fan with forward-curved blades for high performance. Fan is easily removed for cleaning and maintenance, even when the unit is installed.
  - Epoxy-resin painted steel sheet-metal frame with spiral housing, provided with holes to allow the motor to be fitted in any one of eight different positions in respect to the outlet port.
  - Not suitable for speed control.
  - Ambient temperature limits: -25° min. +40°C max.
- Wiring diagrams shown on page XXXVIII.



*These units are only suitable for extracting dust-free, acid-free and non-corrosive air. Their diameters are standardised for easy application using standard ducting. They are ideally suited for ducted applications.*

M: Monophase (Single phase) 220-240 V - 50 Hz





T: Triphase (Three phase) 380 - 415 V - 50Hz

Product	Code	V ~ 50 Hz	W	A	Poles	Rpm	Delivery		P max		Lp dB(A) (3 m)	kg	Insulation	IP	max °C	
							m <sup>3</sup> /h	l/s	mm H <sub>2</sub> O	Pa						
C 10/2 M	30302* 30315	220-240	60-70	0.30-0.31	2	2840	300	59.7	27	262	55.5	2.7	⊕	cl. I	54	40
C 15/2 M	30902* 30915	220-240	131-140	0.68-0.71	2	2830	415	115.3	38	373	59	5	⊕	cl. I	54	40
C 20/2 M	31502* 31515	220-240	415-445	2.4-2.6	2	2800	810	225.0	48	471	66	6	⊕	cl. I	54	40
C 25/2 M	32102* 32115	220-240	465-490	2.6-2.7	2	2800	950	263.9	50	491	66.5	6.8	⊕	cl. I	54	40
C 30/2 M	32702* 32715	220-240	920-950	4.6-4.7	2	2800	1340	372.2	80	785	71	8.4	⊕	cl. I	54	40
C 30/4 M	33354	220-240	210-250	1.08-1.21	4	1400	660	183.3	20	196	55	9	⊕	cl. I	54	40
C 35/4 M	33352	220-240	484-523	2.42-2.44	4	1400	1520	422.2	34	334	61	11	⊕	cl. I	54	40
C 37/4 M	33359	220-240	915-990	4.24-4.25	4	1400	2300	683.9	18	177	70	20.5	⊕	cl. I	54	40
C 40/4 M	33361	220-240	1240-1300	6.27-6.3	4	1400	3200	888.9	39	383	73	21	⊕	cl. I	54	40
C 10/2 T	30351	220/380 240/415	85 94	0.6/0.35 0.67/0.395	2	2800	220	61.1	19	186	55.5	4.6	⊕	cl. I	54	40
C 15/2 T	30951	220/380 240/415	129 136	0.64/0.38 0.68/0.39	2	2800	430	119.4	38	373	59	3.3	⊕	cl. I	54	40
C 20/2 T	31551	220/380 240/415	440 470	2.21/1.28 2.67/1.55	2	2800	810	225.0	48	471	66	5.8	⊕	cl. I	54	40
C 25/2 T	32151	220/380 240/415	460 500	2.14/1.22 2.53/1.43	2	2800	950	263.9	50	491	66.5	6.3	⊕	cl. I	54	40
C 30/2 T	32751	220/380 240/415	900 960	3.11/1.78 3.17/1.85	2	2800	1340	372.2	83	814	71	8.1	⊕	cl. I	54	40
C 30/4 T	33353	220/380 240/415	195 240	1.68/0.94 2/1.12	4	1400	675	187.5	20	196	55	8.1	⊕	cl. I	54	40
C 31/4 T	33355	220/380 240/415	330 370	1.73/1.00 1.98/1.13	4	1400	1055	293.1	29	284	61	9.5	⊕	cl. I	54	40
C 35/4 T	33351	220/380 240/415	433 485	1.88/1.08 2.06/1.16	4	1400	1550	430.6	34	334	61	9.3	⊕	cl. I	54	40
C 37/4 T	33356	220/380 240/415	970 1000	4.1/2.36 4.4/2.5	4	1400	2300	638.9	39	383	70	20.5	⊕	cl. I	54	40
C 40/4 T	34251	220/380 240/415	1160 1200	4.3/2.4 4.33/2.43	4	1400	3150	875	51	500	73	14.6	⊕	cl. I	54	40
C 45/4 T	35151	220/380 240/415	2300 2340	8.4/4.73 8.5/4.84	4	1400	4500	1250	74	726	70.5	23.3	⊕	cl. I	54	40
C 46/4 T	33357	220/380 240/415	3460 3600	15/9.35 18/10	4	1400	6300	1750	94	922	76.5	61	⊕	cl. I	54	40

\* Available only in UK

Conforms with ISO 3744 for noise and pressure levels

## Accessories (description and data on pages 142-145).

Model		Code	Products
	C GM 10 (protection grille for outlet port)	22811	30302 - 30351 - 30315
	C GM 15 (protection grille for outlet port)	22812	30951 - 30902 - 30915
	C GM 20 (protection grille for outlet port)	22813	31502 - 31551 - 31515
	C GM 25 (protection grille for outlet port)	22814	32151 - 32102 - 32115
	C GM 30 (protection grille for outlet port)	22816	32702 - 33353 - 33354 - 32751 - 32715
	C GM 31 (protection grille for outlet port)	22817	33355
	C GM 35 (protection grille for outlet port)	22818	33352 - 33351
	C GM 37 (protection grille for outlet port)	22819	33359 - 33356
	C GM 40 (protection grille for outlet port)	22820	33361 - 34251
	C GM 45 (protection grille for outlet port)	22821	35151
	C GM 46 (protection grille for outlet port)	22822	33357
	C GA 10 (protection grille for intake port)	22801	30302 - 30351 - 30315
	C GA 15 (protection grille for intake port)	22802	30951 - 30902 - 30915
	C GA 20/25 (protection grille for intake port)	22803	31502 - 31551 - 32151 - 32102 - 31515 - 32115
C GA 30 (protection grille for intake port)	22804	32702 - 33353 - 33354 - 32751 - 32715	
C GA 31/35 (protection grille for intake port)	22805	33355 - 33352 - 33351	
C GA 31/35 (protection grille for intake port)	22806	33359 - 33356 - 33361 - 34251	
C GA 45 (protection grille for intake port)	22807	35151	
C GA 46 (protection grille for intake port)	22808	33357	
	C RA 10 (flanged inlet adapter)	22825	30302 - 30351 - 30315
	C RA 15 (flanged inlet adapter)	22826	30951 - 30902 - 30915
	C RA 20 (flanged inlet adapter)	22827	31502 - 31551 - 31515
	C RA 25 (flanged inlet adapter)	22828	32151 - 32102 - 32115
	C RA 30 (flanged inlet adapter)	22829	32702 - 33353 - 33354 - 32751 - 32715
	C RA 31 (flanged inlet adapter)	22830	33355
	C RA 35 (flanged inlet adapter)	22831	33352 - 33351
	C RA 37 (flanged inlet adapter)	22832	33359 - 33356
	C RA 40 (flanged inlet adapter)	22833	33361 - 34251
	C RA 45 (flanged inlet adapter)	22834	35151
	C RA 46 (flanged inlet adapter)	22835	33357
	C MS 20/25 (wall-mounting support)	22836	31502 - 31551 - 32151 - 32102 - 31515 - 32115
	C MS 30 (wall-mounting support)	22837	32702 - 33353 - 33354 - 32751 - 32715
	C MS 31/35 (wall-mounting support)	22838	33355 - 33352 - 33351
	C MS 37/40 (wall-mounting support)	22839	33359 - 33356 - 33361 - 34251
	C MS 45 (wall-mounting support)	22840	35151
	IRM 40 (three-position single-phase speed controller)	12922	31502 - 32102 - 31515 - 32115
	IRT 35 (three-position three-phase speed controller)	12924	31551 - 32151
	IREM 5* (single-phase speed controller)	12932	31502 - 32102 - 31515 - 32115

\* multiple regulation up to max 5 A

## Dimensions (mm) C 10 ÷ C 45

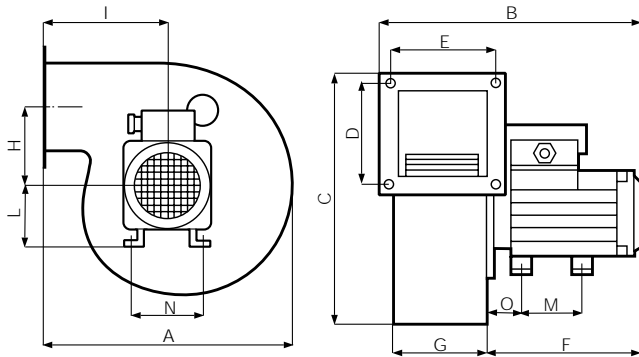

Units normally supplied with the spiral housing oriented LG 90° counter-clockwise.

## C 46

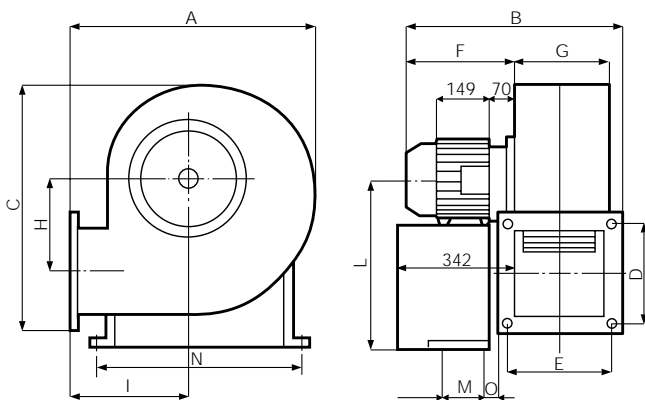

Units normally supplied with the spiral housing oriented LG 270° counter-clockwise.

	A	B	C	D	E	F	G	H	I	L	M	N	P
<b>C 10</b>	171	270	186	72	82	185	71.6	66.5	81	56	71	90	36
<b>C 15</b>	206	291	234	108	100	185	86.6	79	99	56	71	90	36
<b>C 20</b>	232	348	258	123	123	222	106	87	117	71	90	112	45
<b>C 25</b>	232	363	258	124	142	222	119	87	117	71	90	112	45
<b>C 30</b>	272	347	308	126	137	206	122	111	131	71	90	112	45
<b>C 31</b>	340	347	400	164	139	206	117	144	152	71	90	112	45
<b>C 35</b>	340	383	400	164	174	206	154	144	152	71	90	112	45
<b>C 37</b>	416.5	433	471	220	182	247	155	146	181.5	80	100	125	50
<b>C 40</b>	418	454	472	214	208	247	191	147	181.5	80	100	125	50
<b>C 45</b>	484.5	519	557.5	228	228	285	208	217	222	90	125	140	56
<b>C 46</b>	566	571	675	306	265	306	235	244.5	250	442	270	400	27

## Positioning

• The outlet port of a radial extract unit has a symbol showing the direction of rotation. The C Range is counter clockwise (LG) when viewed from the opposite side to the intake port. The axis of reference is perpendicular to the base line (which intersects the rotational axis). The angle between this reference and the orientation of the outlet port is measured in degrees. For example, the radial extract unit on the right is an LG 135.

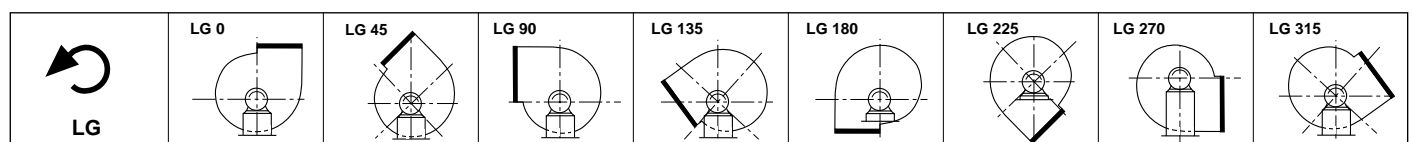
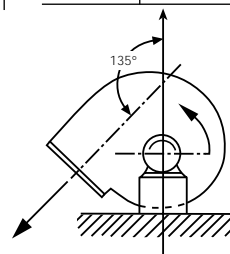

## Dimensions (mm)

### Outlet port

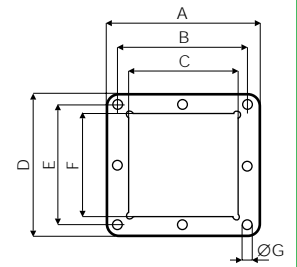

	A	B	C	D	E	F	Ø G	n° holes
<b>C 10</b>	98	82	68	88	72	63	6.5	4
<b>C 15</b>	125	100	83	132	108	88	7	4
<b>C 20</b>	145	123	102	145	123	98	8.5	4
<b>C 25</b>	164	142	115	146	124	98	8.5	4
<b>C 30</b>	162	137	117	150	126	108	8.5	4
<b>C 31</b>	165	139	112	190	164	137	8.5	8
<b>C 35</b>	200	174	149	190	164	137	8.5	8
<b>C 37</b>	218	182	149	250	220	187	8.5	8
<b>C 40</b>	244	208	185	250	214	187	8.5	8
<b>C 45</b>	260	228	200	260	228	200	9	8
<b>C 46</b>	295	265	236	336	306	277	11.5	8

### Intake port

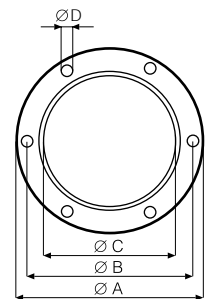

	Ø A	Ø B	Ø C	Ø D	n° holes
<b>C 10</b>	111.5	100	80	7	6
<b>C 15</b>	141	128	108	7	6
<b>C 20</b>	152	132	108	7	6
<b>C 25</b>	152	132	108	7	6
<b>C 30</b>	190	170	132	7	6
<b>C 31</b>	240	220	170	8.5	8
<b>C 35</b>	240	220	170	8.5	8
<b>C 37</b>	282	262	199	8.5	8
<b>C 40</b>	282	262	199	8.5	8
<b>C 45</b>	320	300	236	8.5	8
<b>C 46</b>	420	395	288	8.5	8

# Pressure/performance curves

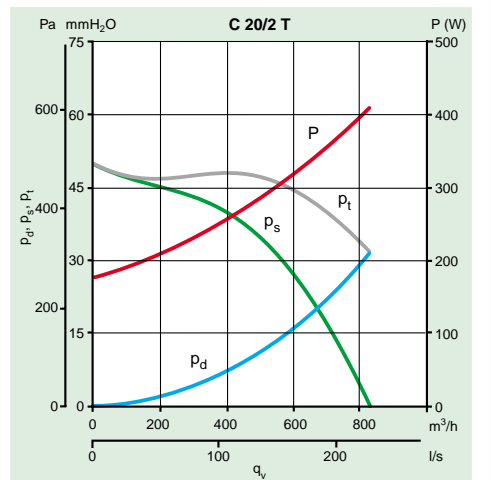
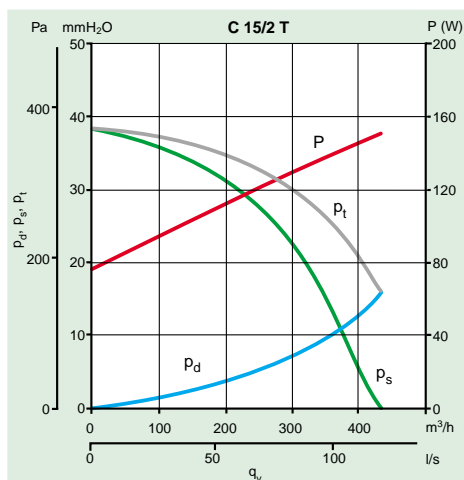
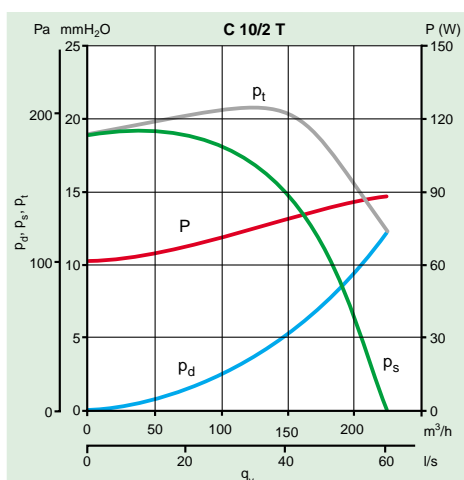
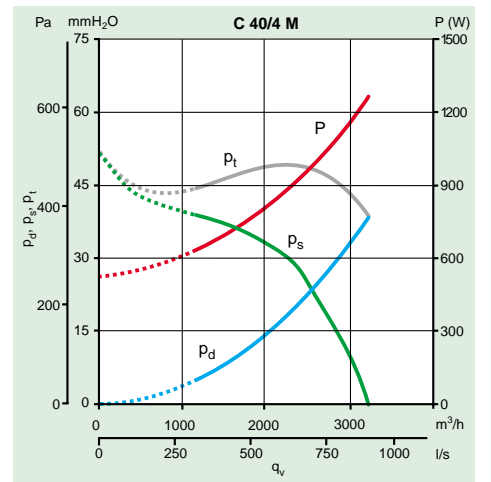
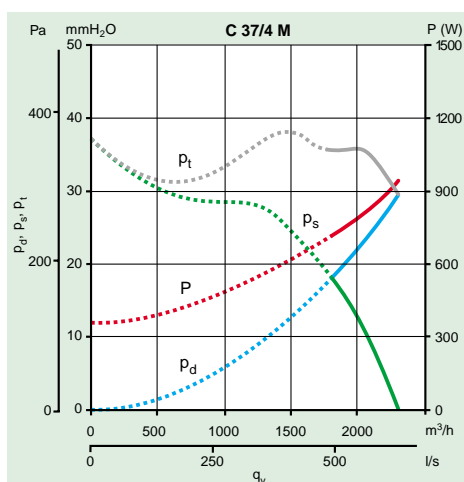
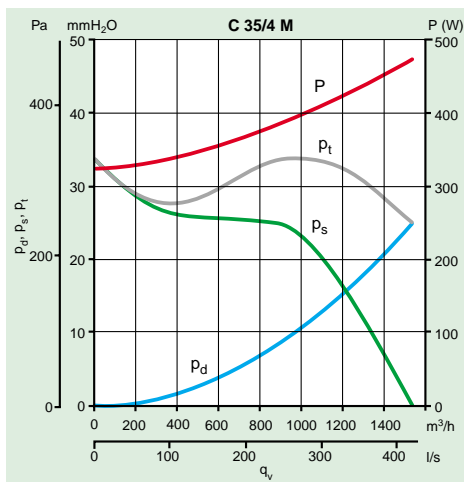
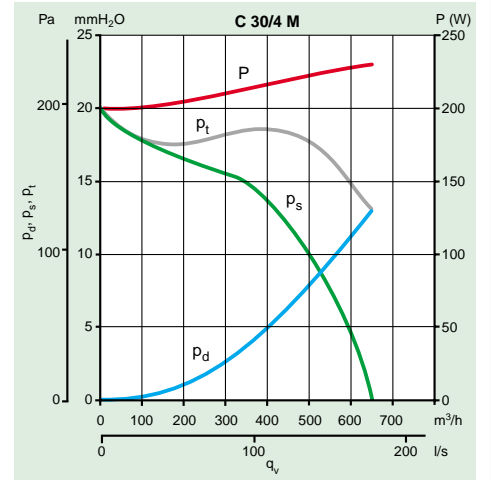
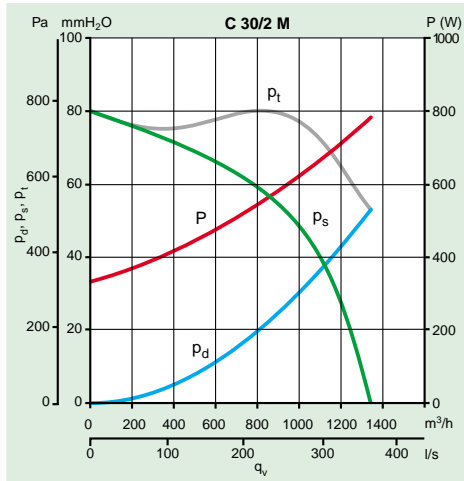
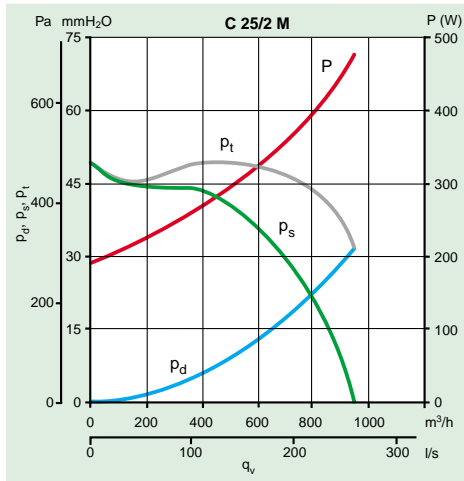
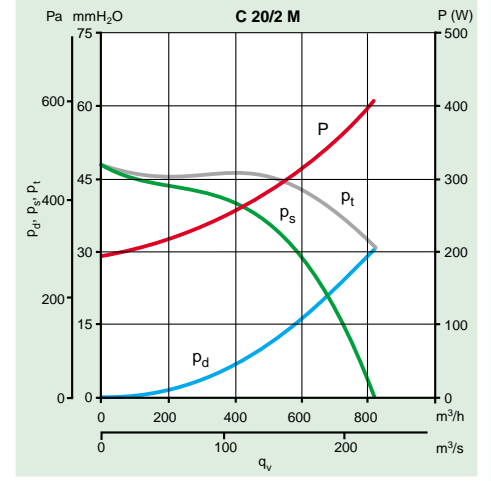
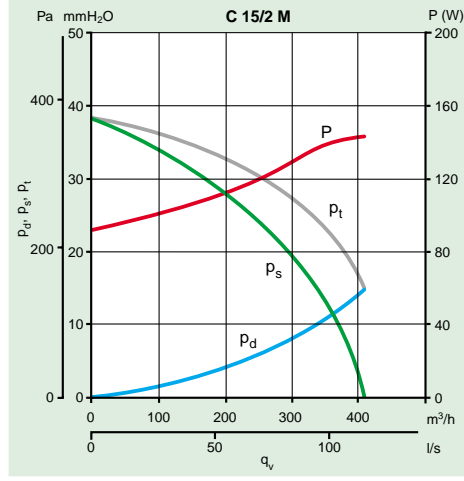
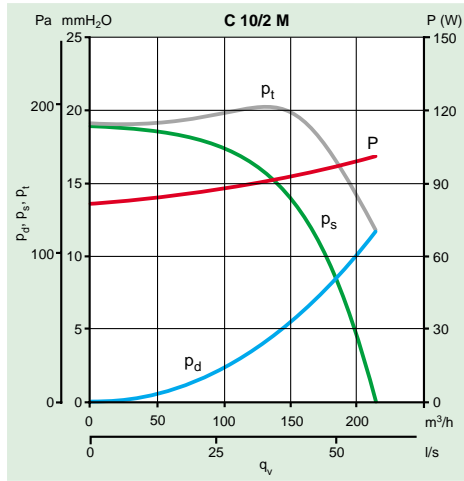

## Pressure/performance curves

